

**CERTIFICATE OF APPROPRIATENESS**

**Application Date:** August 18, 2022

**Applicant:** Karen Brasier, agent for, Tracy Boulware, owner

**Property:** 1543 Columbia Street, Lot 2, Block 137, Houston Heights Neighborhood Subdivision. The property includes a historic 864 square foot, one-story wood frame single-family residence and a detached garage situated on a 6,6000 square foot (50' x 132') interior lot.

**Significance:** Contributing Bungalow style residence, constructed circa 1920, located in the Houston Heights East Historic District.

**Proposal:** Alteration: Addition

- Raise existing historic structure 4" (from 26" to 30")
- Extend rear ridge line of historic structure back to rear addition at a lower height to differentiate
- 2-story rear addition
- Max. ridge height at 29' 4" with a 6:12 roof pitch (matches contributing structure's roof pitch)
- Attached garage with alley access
- On South elevation of historic structure, move existing window and infill.
- On North elevation of historic structure, move existing window and infill. Create new window opening with pair of windows.
- Single-hung, inset & recessed, 1/1, wood windows
- Smooth, cementitious siding
- **Information Subject To Change Before Final Report**

**Public Comment:** No public comment received.

**Civic Association:** No comment received.

**Recommendation:** Approval  
**HAHC Action:** -

**APPROVAL CRITERIA**

**ALTERATIONS, REHABILITATIONS, RESTORATIONS AND ADDITIONS**

Sec. 33-241: HAHC shall issue a certificate of appropriateness for the alteration, rehabilitation, restoration or addition of an exterior feature of (i) any landmark, (ii) protected landmark, (iii) any building, structure or object that is part of an archaeological site, or (iv) contributing building in a historic district upon finding that the application satisfies the following criteria, as applicable:

**S D NA**

**S - satisfies D - does not satisfy NA - not applicable**

- (1) The proposed activity must retain and preserve the historical character of the property;
- (2) The proposed activity must contribute to the continued availability of the property for a contemporary use;
- (3) The proposed activity must recognize the building, structure, object or site as a product of its own time and avoid alterations that seek to create an earlier or later appearance;
- (4) The proposed activity must preserve the distinguishing qualities or character of the building, structure, object or site and its environment;
- (5) The proposed activity must maintain or replicate distinctive stylistic exterior features or examples of skilled craftsmanship that characterize the building, structure, object or site;
- (6) New materials to be used for any exterior feature excluding what is visible from public alleys must be visually compatible with, but not necessarily the same as, the materials being replaced in form, design, texture, dimension and scale;
- (7) The proposed replacement of exterior features, if any, should be based on an accurate duplication of features, substantiated by available historical, physical or pictorial evidence, where that evidence is available, rather than on conjectural designs or the availability of different architectural elements from other structures;
- (8) Proposed additions or alterations must be done in a manner that, if removed in the future, would leave unimpaired the essential form and integrity of the building, structure, object or site;
- (9) The proposed design for any exterior alterations or addition must not destroy significant historical, architectural, archaeological or cultural material, including but not limited to siding, windows, doors and porch elements;
- (10) The proposed alteration or addition must be compatible with the massing, size, scale material and character of the property and the context area; and
- (11) The distance from the property line to the front and side walls, porches, and exterior features of any proposed addition or alteration must be compatible with the distance to the property line of similar elements of existing contributing structures in the context area.

**HEIGHTS DESIGN GUIDELINES**

- In accordance with Sec. 33-276, the proposed activity must comply with the City Council approved Design Guidelines.

District Map

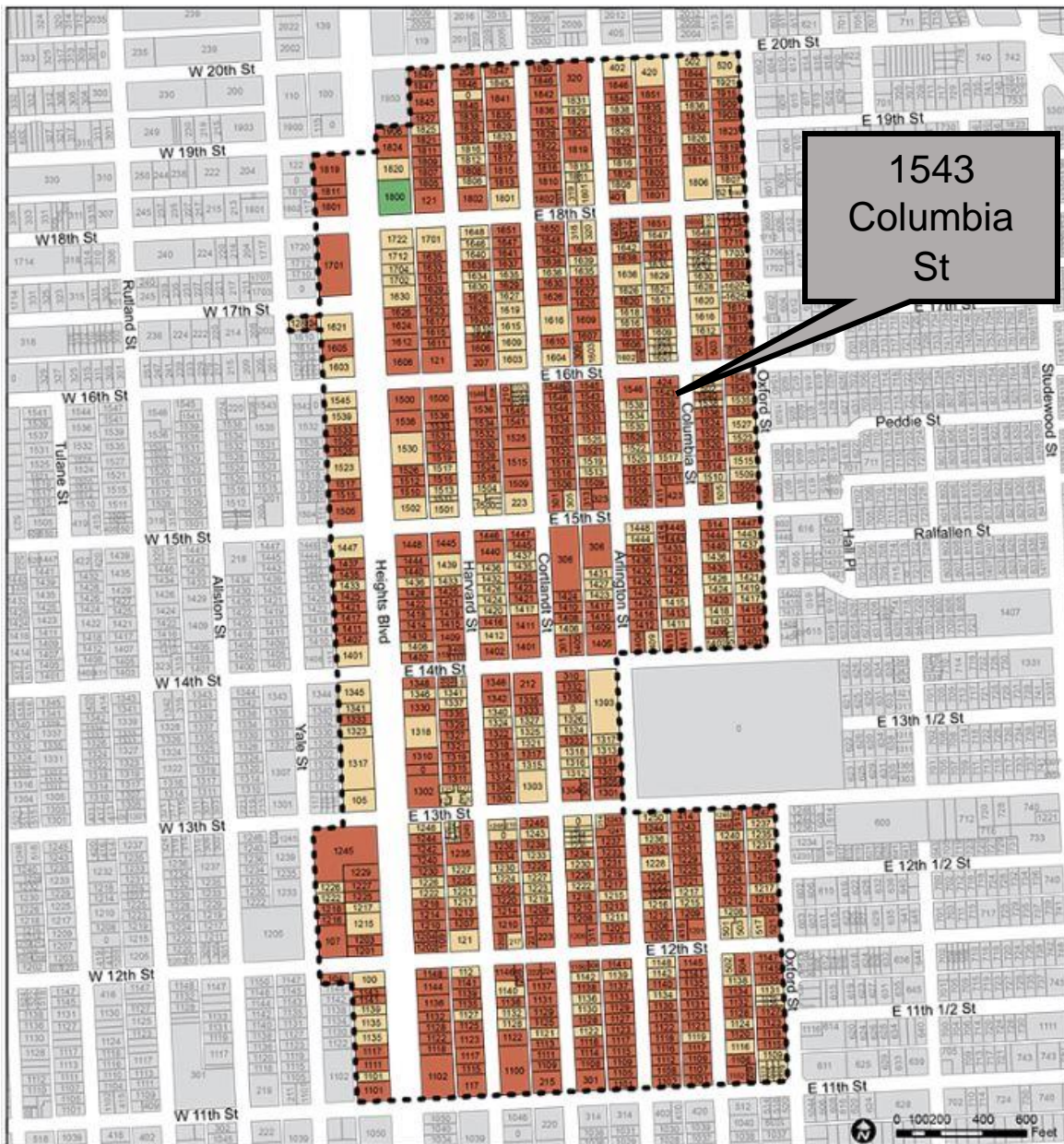

Houston Heights East Historic District

Historic District Boundary



Building Classification

- Contributing
- Non-Contributing
- Park

Established: February 20, 2008

Source: GIS Services Division

Date: May 1, 2013

Reference: pj17025\_Heights\_East

This map is made available for reference purposes only and should not be substituted for a survey product. The City of Houston will not accept liability of any kind in conjunction with its use.



PLANNING & DEVELOPMENT DEPARTMENT

Inventory Photo



Sanborn – 1543 Columbia St

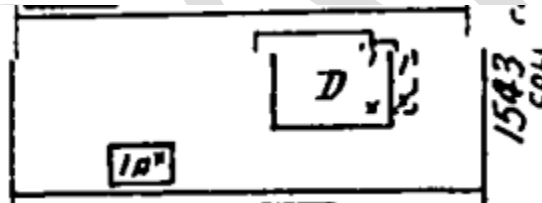

Harris County Building Land Assessment – August 1978

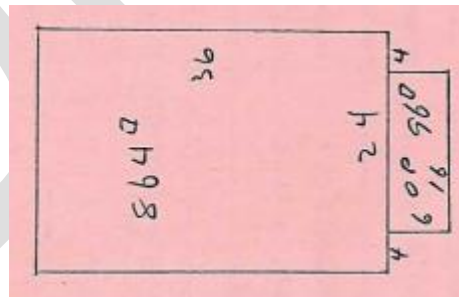

**HEIGHTS DESIGN GUIDELINES MEASURABLE STANDARDS**

**S D NA**      S - satisfies    D - does not satisfy    NA - not applicable

     Maximum Lot Coverage (Addition and New Construction)

LOT SIZE	MAXIMUM LOT COVERAGE
<b>&lt;4000</b>	.44 (44%)
<b>4000-4999</b>	.44 (44%)
<b>5000-5999</b>	.42 (42%)
<b>6000-6999</b>	.40 (40%)
<b>7000-7999</b>	.38 (38%)
<b>8000+</b>	.38 (38%)

Existing Lot Size: 6,600

Max. Allowed: 2,640

Proposed Lot Coverage: 1,934

Remaining Amount: 706

     Maximum Floor Area Ratio (Addition and New Construction)

LOT SIZE	MAXIMUM FAR
<b>&lt;4000</b>	.48
<b>4000-4999</b>	.48
<b>5000-5999</b>	.46
<b>6000-6999</b>	.44
<b>7000-7999</b>	.42
<b>8000+</b>	.40

Existing Lot Size: 6,600

Max. FAR Allowed: 2,904

Proposed FAR: 2,900

Remaining Amount: 4

Side Wall Length and Insets (Addition and New Construction)

MEASUREMENT	APPLICATION
50 FT.	Maximum side wall length without inset (1-story)
40 FT.	Maximum side wall length without inset (2-story)
1 FT.	Minimum depth of inset section of side wall (1-story)
2 FT.	Minimum depth of inset section of side wall (2-story)
6 FT.	Minimum length of inset section of side wall

Side Wall Length: 38' 2" (Historic Structure: Original Corners Preserved)

Inset Length: 7' 5"

Inset on North side: 5'

Inset on South side: 2'

Side Setbacks (Addition and New Construction)

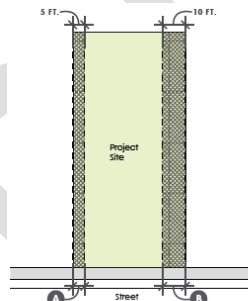

Note: This diagram shows just one example of a side setback configuration.

KEY	MEASUREMENT	APPLICATION
A	3 FT.	Minimum distance between side wall and the property line for lots less than 35 feet wide
B	5 FT.	Minimum distance between the side wall and the property line
	<b>REMAINING</b>	Difference between minimum side setback of 5 feet and minimum cumulative side setback
C	6 FT.	Minimum cumulative side setback for lots less than 35 feet wide
	10 FT.	Minimum cumulative side setback for a one-story house
	15 FT.	Minimum cumulative side setback for a two-story house

Proposed side setback (North): 7' 1"

Proposed side setback (South): 9' 1"

Cumulative side setback: 16' 2"



Eave Height (Addition and New Construction)

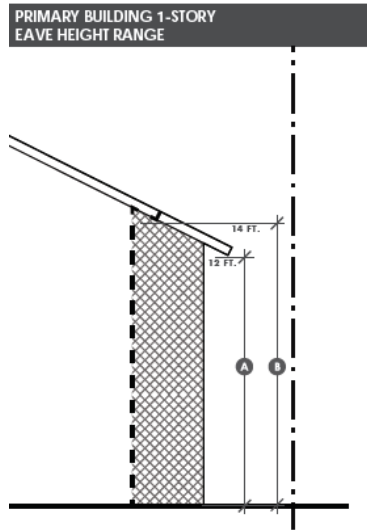

KEY	MEASUREMENT	APPLICATION
A	12 FT.	Maximum 1-story eave height at the 5 FT. minimum side setback
B	14 FT.	Maximum 1-story eave height at 7 FT. or greater side setback

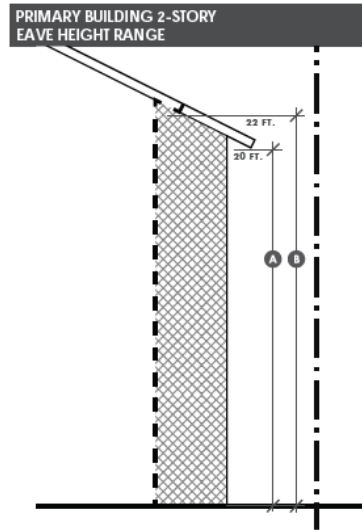

KEY	MEASUREMENT	APPLICATION
A	20 FT.	Maximum 2-story eave height at the 5 FT. minimum side setback
B	22 FT.	Maximum 2-story eave height at 7 FT. or greater side setback

Proposed eave height: 21' 1"

**HEIGHTS DESIGN GUIDELINES MEASURABLE STANDARDS**

Rear Setbacks (Addition and New Construction)

The City of Houston requires a minimum setback of three feet from the rear property line for all properties, except under the following circumstances:

- A front-facing garage which is located with its rear wall at the alley may have a zero-foot setback.
- An alley-loading garage generally must be located to establish a minimum of 20 feet of clearance from an opposing alley-loading garage door, the rear wall of a front-facing garage, or a fence; a 24-foot clearance is preferred.

Proposed rear setback: 9' 1"

Porch Eave Height (Addition and New Construction)

MEASUREMENT	APPLICATION
9-11 FT.	Minimum and maximum 1-story porch eave height.

Proposed porch eave height: 9' 1"



- 

Building Wall (Plate) Height (Addition and New Construction)

MEASUREMENT	APPLICATION
36 IN.	Maximum finished floor height (as measured at the front of the structure)
10 FT.	Maximum first floor plate height
9 FT.	Maximum second floor plate height

Proposed finished floor: 2' 6"  
 Proposed first floor plate height: 10'  
 Proposed second floor plate height: 8'

- 

Detached Garage Ridge Height (New Construction)

**GARAGE 1-STORY RIDGE HEIGHT**

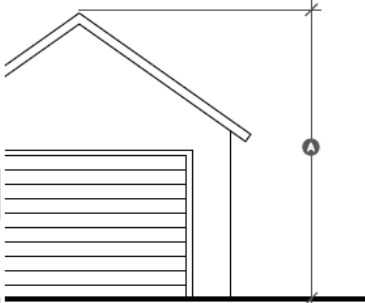

KEY	MEASUREMENT	APPLICATION
A	16 FT.	Maximum 1-story garage ridge height

**GARAGE 2-STORY RIDGE HEIGHT**

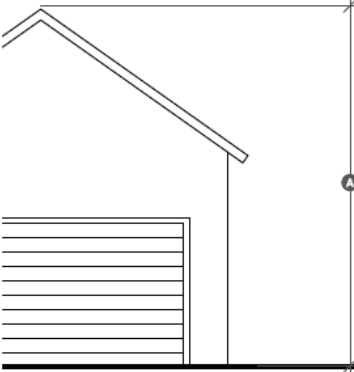

KEY	MEASUREMENT	APPLICATION
A	26 FT.	Maximum 2-story garage ridge height (for garage apartment)

Proposed ridge height: 22' 8"

The following measurable standards are not applicable to this project:

- Front Setbacks

Existing Site Plan

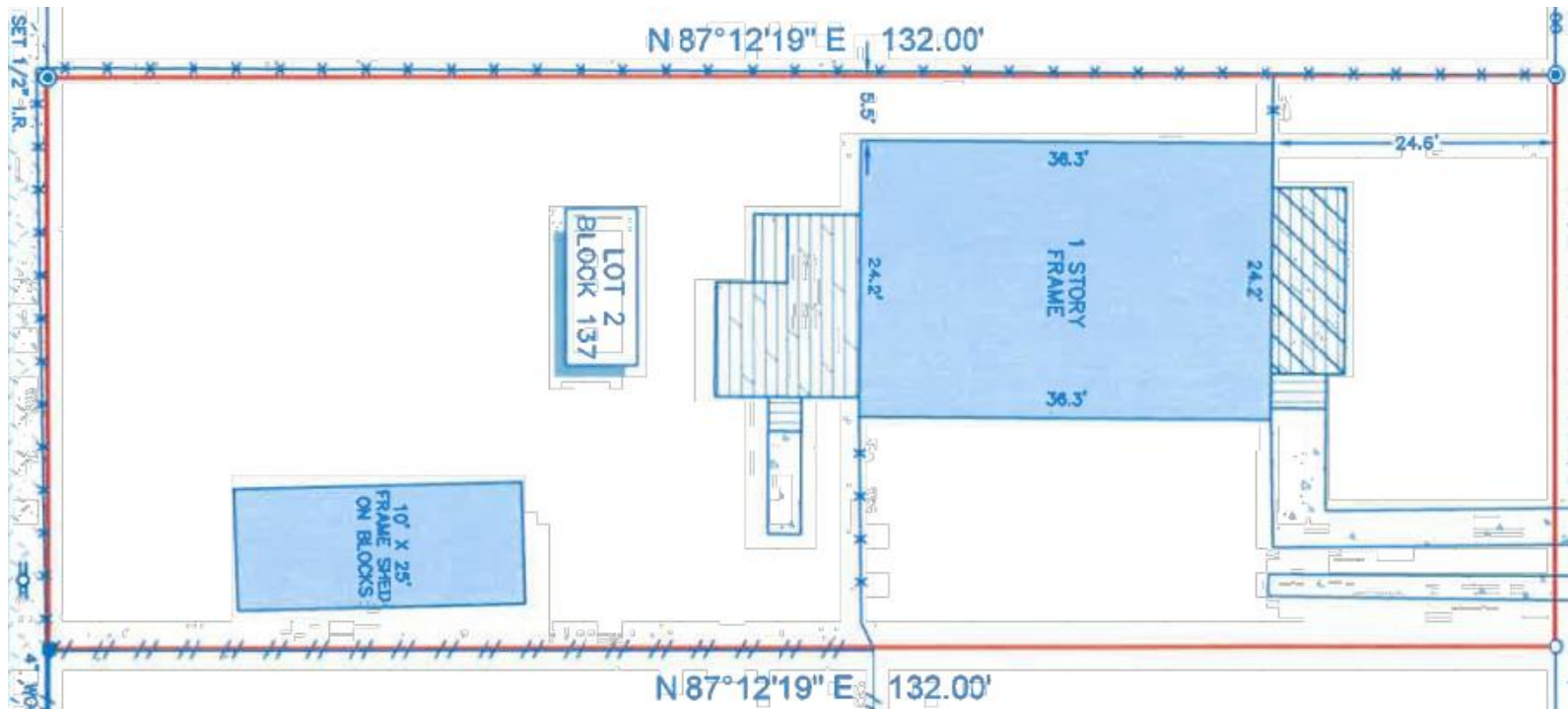

Proposed Site Plan

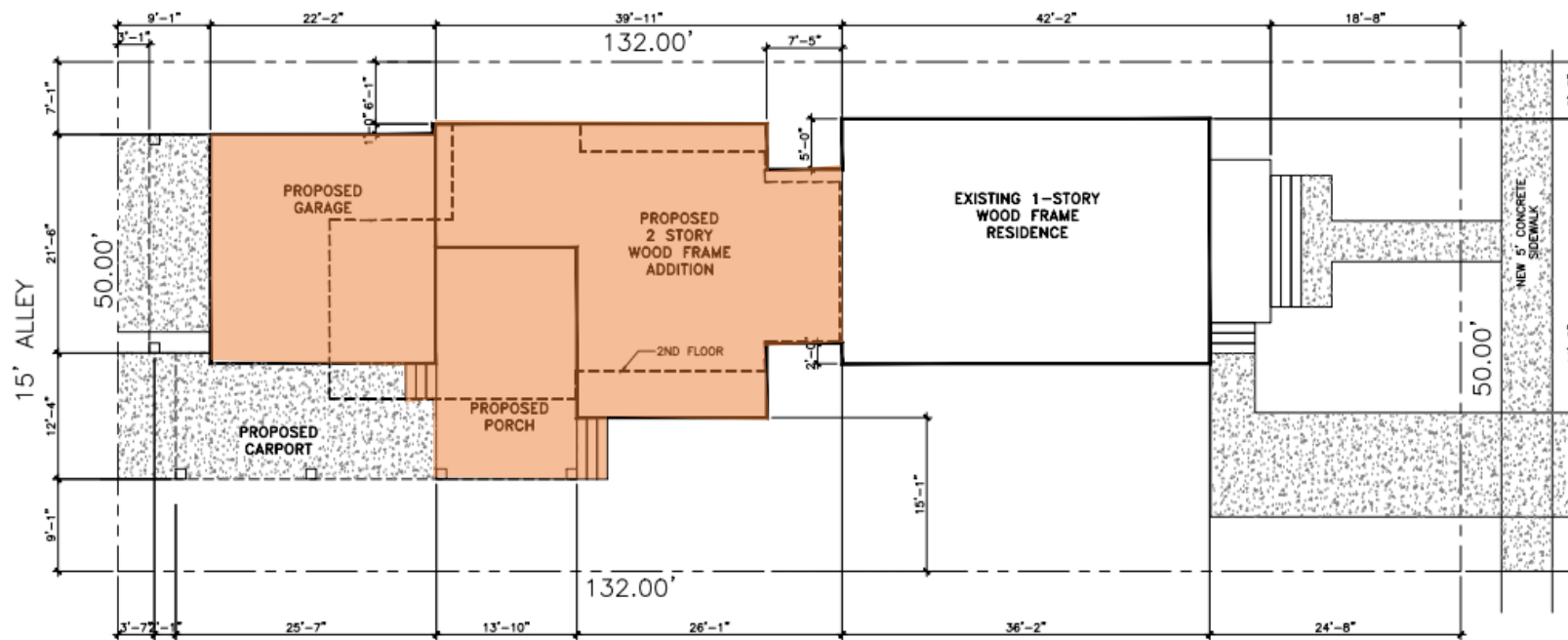

Existing Floor Plan

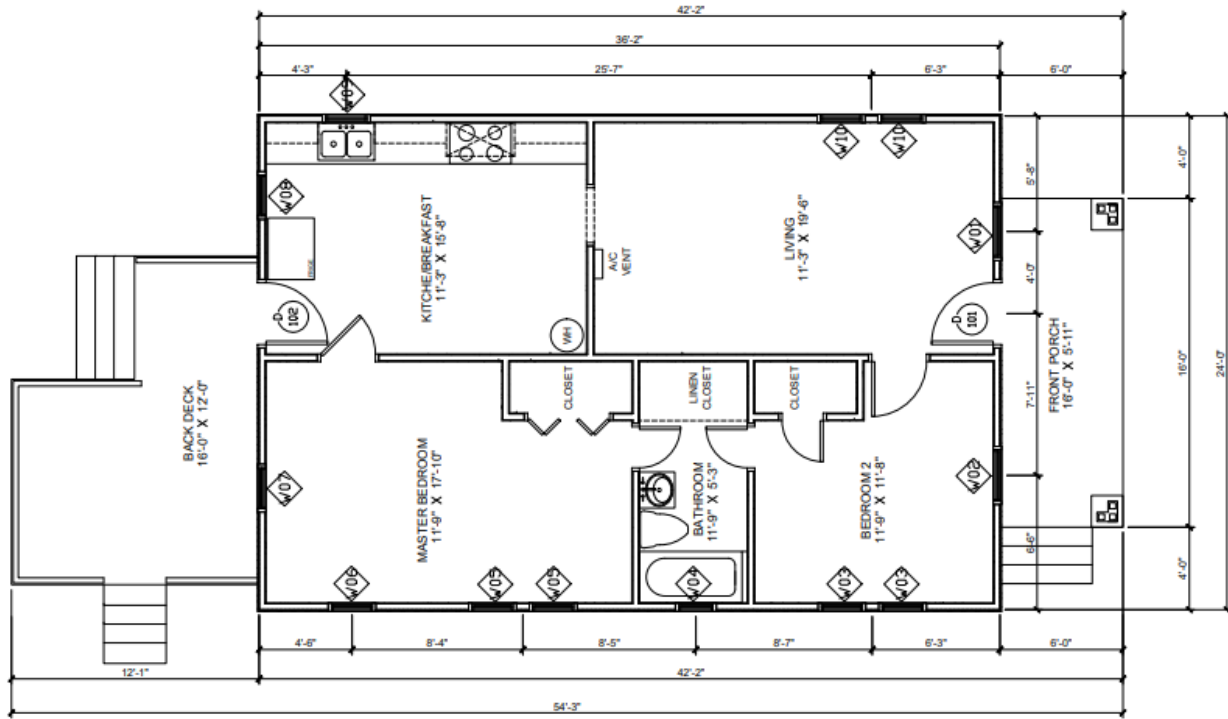

Proposed First Floor Plan

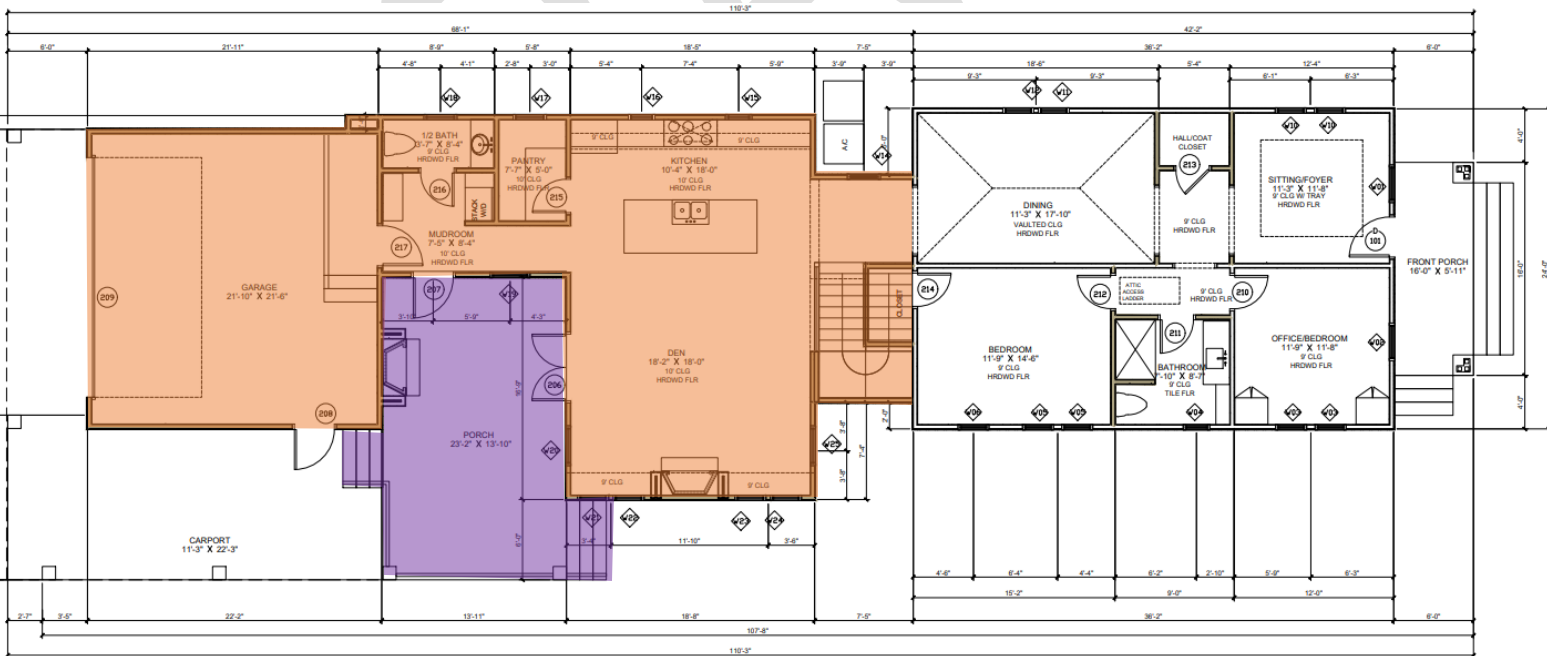

### Proposed Second Floor Plan

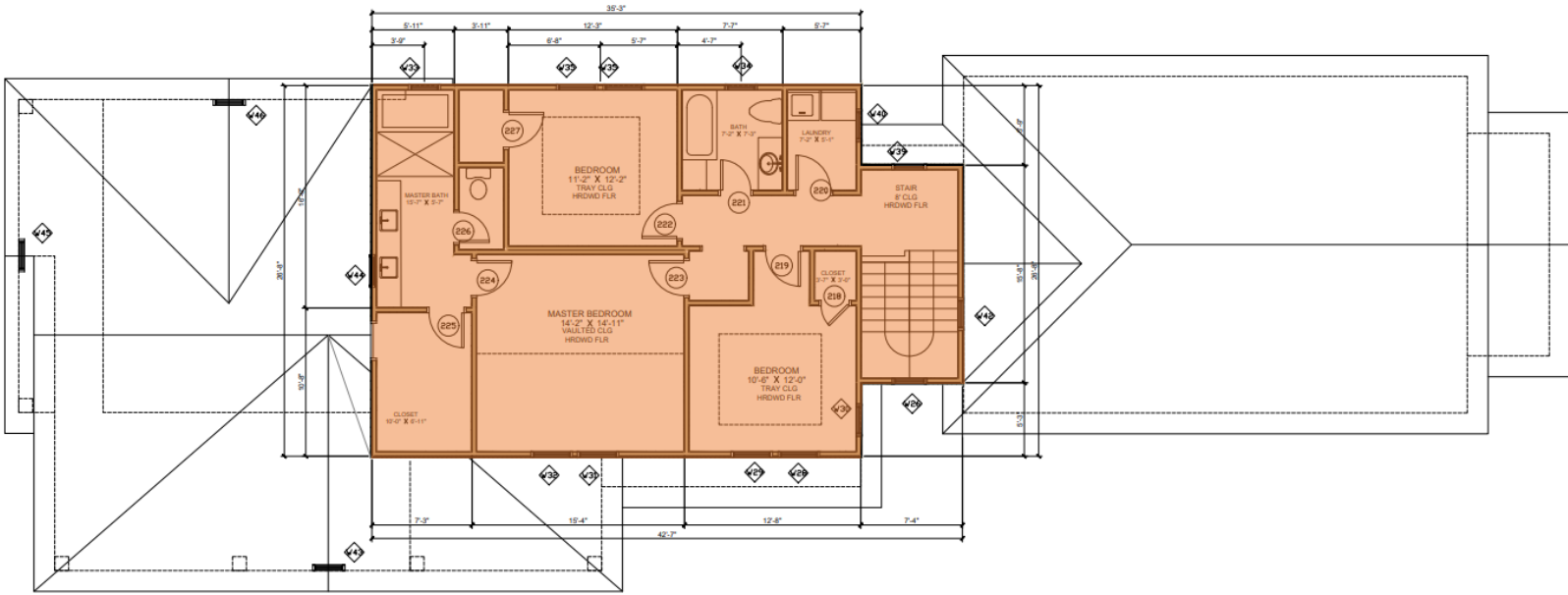

### Proposed Roof Plan

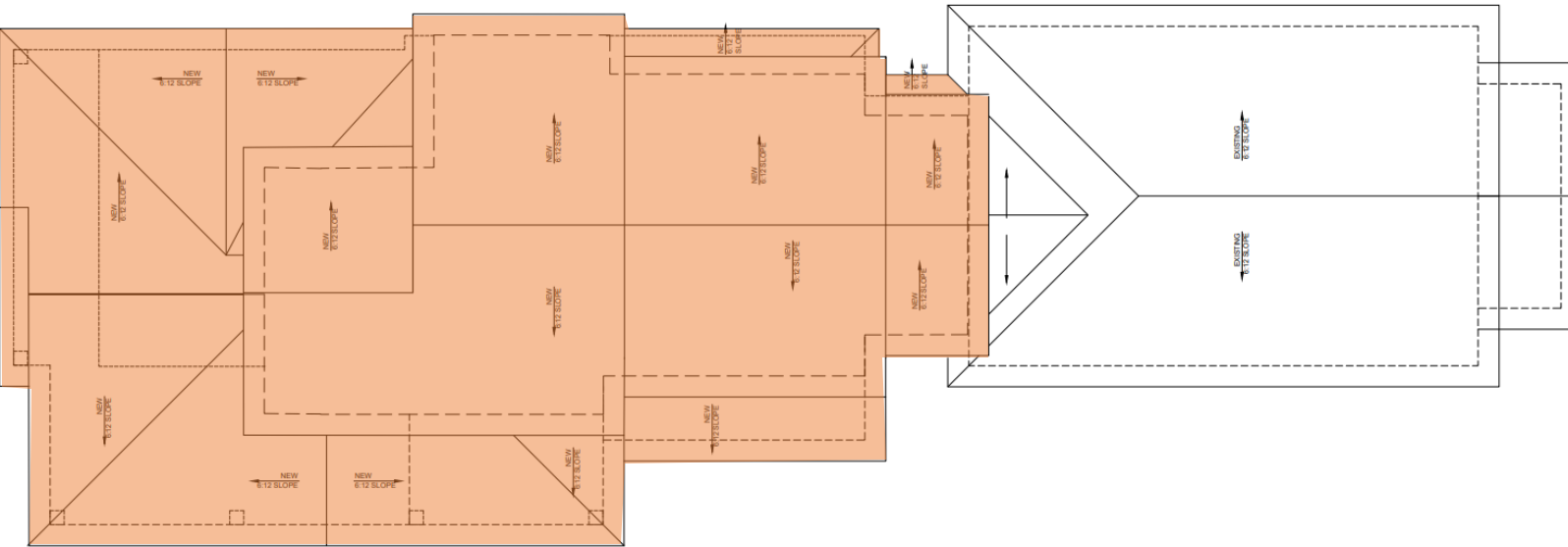

Existing Front (East) Elevation



Proposed Front (East) Elevation



**Existing Rear (West) Elevation**



**Proposed Rear (West) Elevation**



Existing Left (South) Elevation

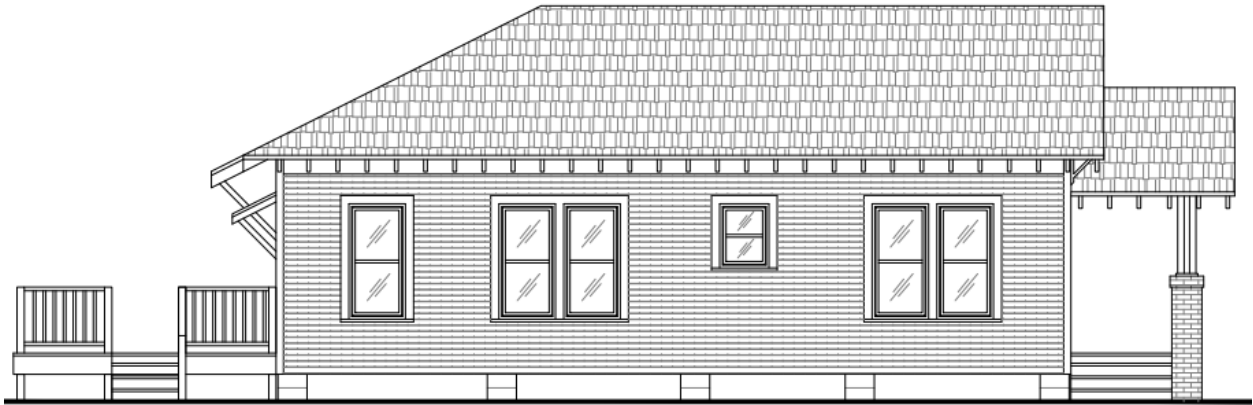

Proposed Left (South) Elevation



**Existing Right (North) Elevation**

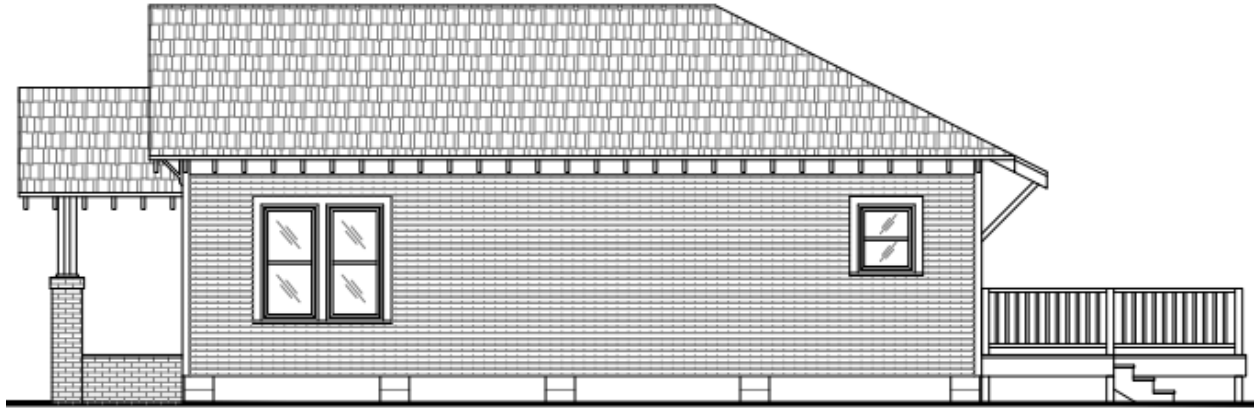

**Proposed Right (North) Elevation**

